

WEIGH-TRONIX

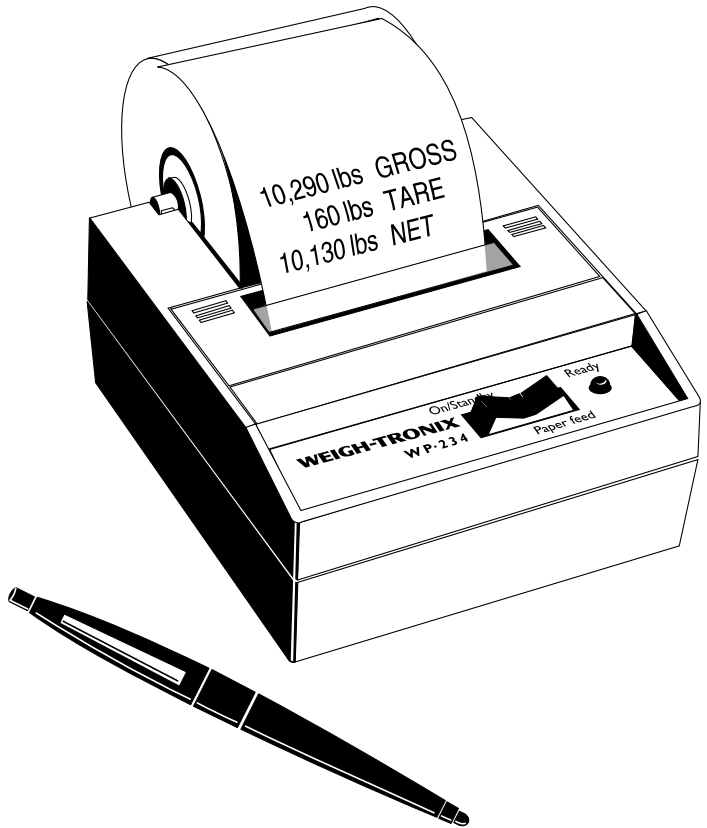

WP-234 Printer User's Manual

UNITED STATES

This equipment has been tested and found to comply with the limits for a Class A digital device, pursuant to Part 15 of the FCC Rules. These limits are designed to provide reasonable protection against harmful interference when the equipment is operated in a commercial environment. This equipment generates, uses, and can radiate radio frequency energy and, if not installed and used in accordance with the instruction manual, may cause harmful interference to radio communications. Operation of this equipment in a residential area is likely to cause harmful interference in which case the user will be required to correct the interference at his own expense.

CANADA

This digital apparatus does not exceed the Class A limits for radio noise emissions from digital apparatus set out in the Radio Interference Regulations of the Canadian Department of Communications.

Le present appareil numerique n'emet pas de bruits radioelectriques dépassant les limites applicables aux appareils numeriques de la Class A prescrites dans le Reglement sur le brouillage radioelectrique que edicte par le ministere des Communications du Canada.

EUROPEAN COUNTRIES

WARNING

This is a Class A product. In a domestic environment this product may cause radio interference in which the user may be required to take adequate measures.



CAUTION

Risk of electrical shock. Do not remove cover. No user serviceable parts inside. Refer servicing to qualified service personnel.

Weigh-Tronix reserves the right to change specifications at any time.

Table of Contents

Introduction	1
Installation	1
Installing the Paper	1
To Remove the Paper Roll	4
Operation	5
Connecting and Powering Up Your Printer	5
Maintenance	5
Changing the Printer Ribbon	6
Inserting a Ribbon with Paper in the Printer	7
Printer Test and Setup	8
Printer Test	8
Accessing the Setup Menu	9
CONFIGURE	9
CUSTOM.	12
SETCLOCK.	16
RESET SEQ#	17
Communication	18
RS-232 Serial Version	18
20 mA Current Loop Version	19
Control Codes	20

Specifications

Interface-Serial	<i>Available BAUD rates:</i> 300, 600, 1200, 2400, 4800, 9600, 19200 <i>Voltage levels:</i> RS-232C: -9 Volts to + 9 Volts 20mA current loop <i>Character format:</i> ASCII character set—10 bits per character required, 7 or 8 of which are data bits. Parity selection is even or odd for 7 data bits. Busy signal - Clear to Send (CTS, XON-XOFF)
Character Buffering	<i>1.5K standard</i>
Print Method	Impact dot matrix
Character Matrix	5 x 5, 5 x 7, 5 x 8 dot matrix
Character Spacing	24 column: 12.8 characters/inch 32 column: 17 characters/inch 40 column: 21 characters/inch
Line Feed Spacing	7.4 lines per inch
Print Speed	130 lines per minute for 24 column 110 lines per minute for 32 and 40 column
Paper	Table top: 2.25"W x 2.75"D; 0.44" I.D. Panel mount: 2.25"W x 1.25"D
Power	1.5 Watts (idle), 15 Watts maximum while printing
AC Voltage	9 VAC (120 VAC stepdown converter incl.) Multi-national converters optional
DC Voltage	Optional 9-12 VDC 140mA idle, 1 amp with 100% printing, 5.5 amp peak with 100% printing
External Dimensions	4.6"W x 5.0"L x 2.2"H
Operating Temp.	5°C - 40°C, 41°F - 104°F

Print Head Life	1,500,000 lines mean character before failure.
Ribbon life	Black- 200,000 characters Purple-250,000 characters
Paper	Large roll - 12,500 lines Small roll - 3,000 lines

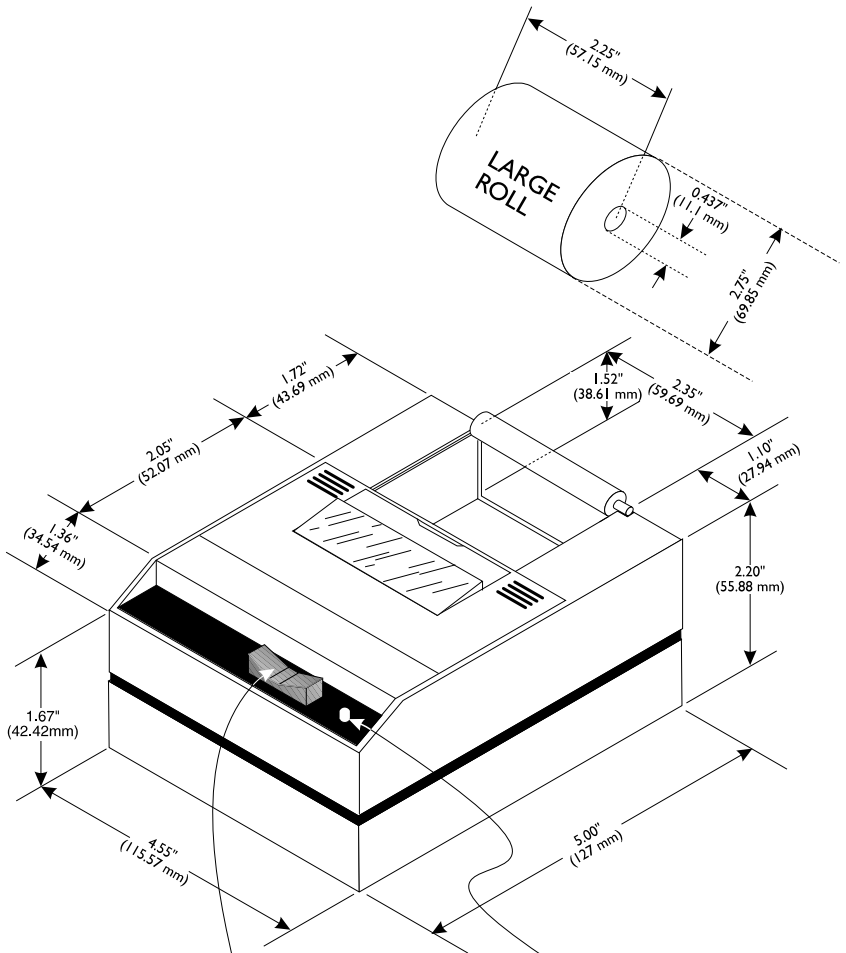

Rocker Switch
 Left side - Toggles printer on and offline
 Right side - Paper Feed

Ready Indicator

Introduction

The Model WP-234 dot matrix printer has one of these electrical interfaces:

- RS-232 Serial
- 20 mA Current Loop

This manual is split into the following main sections:

- Introduction
- Installation
- Operation
- Maintenance
- Printer Test and Setup
- Communication

Installation

Please follow the precautions listed below when setting up your printer. They are designed to help you keep your printer working at its best.

- * Plug your power supply into an appropriate grounded outlet.
- * Place your printer on a flat hard surface, like a tabletop.
- * Keep your printer out of direct sunlight.

Installing the Paper

1. Remove the printer cover by pressing on the groove patterns to pop the front edge up. Lift off the cover.
2. Press the rocker switch to the left. The light will go off.

3. Unroll several inches of the paper.

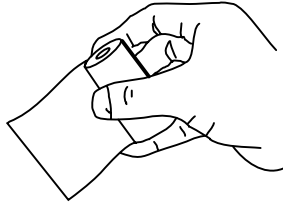

4. Cut a straight edge on the paper roll if it is jagged. This will facilitate the entry of the paper into the printer.
5. Slide the paper through the slot connecting the paper compartment and the printer compartment. You can slide it in about one-quarter inch before it stops.

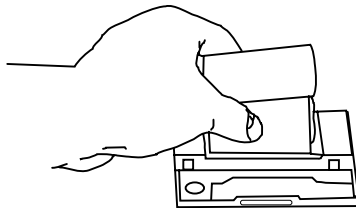
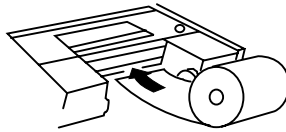

6. While holding the paper in place, press the rocker switch to the Paper Feed position. The printer will activate, and a rubber roller will pull the paper into the printer compartment. Hold the switch in the Paper Feed position until the paper emerges from the top of the printer mechanism.
7. When an inch of paper has emerged from the top of the printer, release the Paper Feed button
8. Now pull the paper through the printer, until several inches are exposed.

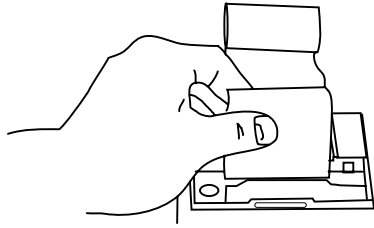

9. Slide the paper through the slot in the printer cover.

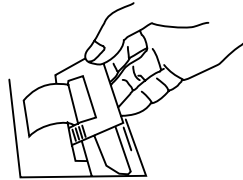

10. Push the back of the printer cover down and into place.

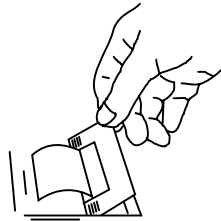

11. Press the front of the printer cover down to lock in place.

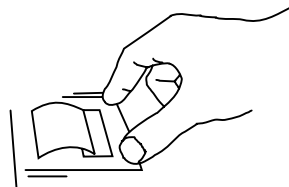

12. Put the paper spindle into the paper roll as shown below, and place the roll with the spindle onto the snaps near the back of the printer. Turn the paper roll to take up any slack in the paper feeding to the printer. Make sure the roll of paper turns freely. If it does not turn freely, the paper will jam and will possibly damage the printer mechanism.

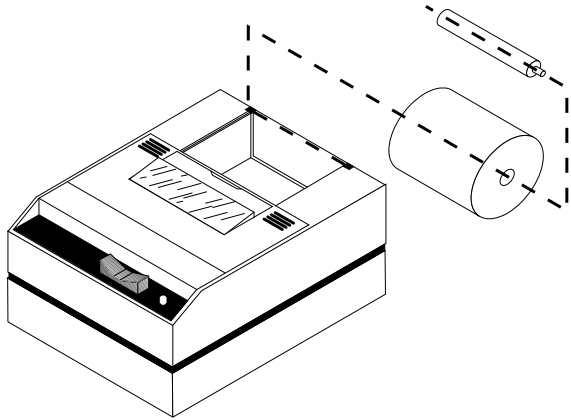

To Remove the Paper Roll

1. Advance the paper about one inch beyond the paper cutter by using the Paper Feed switch.
2. Lift the paper roll away from the printer housing and cut the paper feeding to the printer with scissors. Try to make the cut as square as possible to help the next time you reload the paper.
3. Pull the remaining paper through the printer mechanism. **Be sure to pull the paper from the top** (paper cutter side).

WARNING! Pulling the paper out of the back of the printer will damage the print mechanism.

Operation

Connecting and Powering Up Your Printer

For DC modified units supplied with cable, connect positive voltage to striped wire.

1. Attach the appropriate cable between the printer and your instrument. The connector on the printer side is "keyed" so that you cannot plug the cable in the wrong way. This means that the pins should be positioned so that a slight pressure will seat the cable properly. Do not force the pins in. Doing so could damage the cable.
2. Plug the power cord into the back of the printer. Plug the transformer into an appropriate AC outlet. The unit will power up automatically and print **Ready**. . . This means the printer is ready to print.

The Paper Feed switch on the printer is a rocker type switch. Push the left side of the rocker switch to toggle the printer on and offline. Push the right side of the switch to advance the paper.

Your printer is now ready for printing.

The printer stores characters for printing until one of two things happens:

1. The line buffer is filled.
2. It receives a line feed (hexadecimal 0A) or a carriage return (hexadecimal 0D) code.

When (1) or (2) occurs, the printer prints out the contents of its line buffer. If the buffer is empty when the carriage return is received, the printer simply advances the paper one line, leaving a blank line in the printout.

Maintenance

When printing becomes faint or difficult to see, replace the ribbon in your printer with an Epson ERC-09 cartridge ribbon.

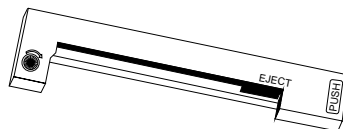

Changing the Printer Ribbon

If your printer is used infrequently, the print impression may become weak because the ribbon dried out. To advance the ribbon to a new section, hold down the Paper Feed switch for several seconds.

Below are the steps for replacing the ribbon:

1. Turn the printer to Standby.
2. Four small grooves are embossed on each side of the printer cover. Push down on one or both of these areas until the printer cover tilts.

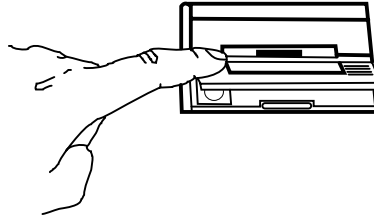
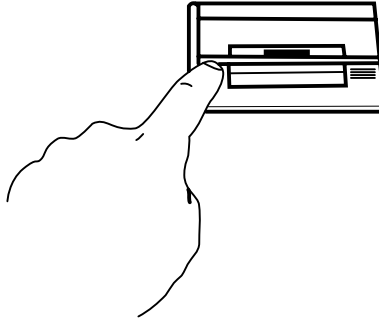

3. When the printer cover is tilted up, lift it completely off.
4. Push down on the right side of ribbon cartridge where it is marked "PUSH". Remove the cartridge.

Cartridge ribbon

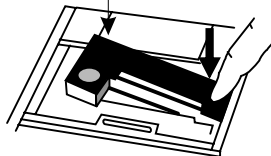

5. Install cartridge. Be sure the ink cartridge is inserted firmly to prevent weak or irregular printing. The cartridge must be properly seated and aligned for best printing.

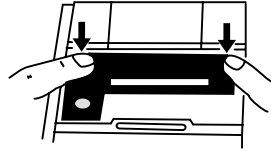

6. Turn the cartridge "knob" (marked by an arrow) clockwise to stretch the ribbon.

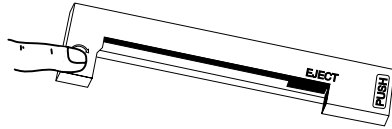

7. Replace the cover.
8. Replace the paper.

Inserting a Ribbon with Paper in the Printer

You may insert the ribbon cartridge if there is already paper in the printer.

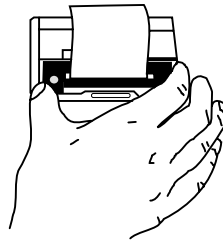

If you get ribbon ink on the printer case, wipe it off immediately. Once it dries it is difficult to remove.

Hold the cartridge as shown above and slide it over the paper and into the printer compartment. Be sure the paper goes between the ribbon cartridge and the ink ribbon.

Printer Test and Setup

Printer Test

The printer can be tested and setup using the steps described in this section. Testing and setup are done using the rocker switch on the printer.

With the printer unplugged at the outlet or at the back of the printer, press and hold the right side of switch as you plug the unit in. The printer will print out a list of the configuration as it currently exists then do a continuous print test. To stop the print test press either side of the rocker switch. Below is a sample of what is printed when you do the print test.

```
** PRINTER TEST **
Serial Version X125X3
RevX3
BAUD=1200
DATA BITS=8
PARITY=NONE
STOP BITS=1
HSHAKE=BUSY-BUFF
COLS=32
FONT=5x7
INVERT=NO
MAG=NONE
BUFFER: 1.5K
INT RAM: OK
ROM: OK
EEPROM: OK
! " # $ % & ' ( ) * + , - . / 0 1 2 3 4 5 6 7 8 9 : ; < = > ? @
" # $ % & ' ( ) * + , - . / 0 1 2 3 4 5 6 7 8 9 : ; < = > ? @ A
# $ % & ' ( ) * + , - . / 0 1 2 3 4 5 6 7 8 9 : ; < = > ? @ A B
$ % & ' ( ) * + , - . / 0 1 2 3 4 5 6 7 8 9 : ; < = > ? @ A B C
Ready...
```

Accessing the Setup Menu

To access the setup menu follow these steps:

1. Unplug the printer either at the outlet or at the back of the printer.
2. Press and hold down the left side of the rocker switch and plug in the printer. The printer will advance the paper. After the paper advance has stopped, count 3-5 seconds and release the switch. The following is printed:

```
*** SETUP MENU ***  
CONFIGURE... [NEXT/OK]
```

If you wait less than three or more than five seconds **Ready. . .** is printed and you will have to try steps 1 and 2 again to access the setup menu.

After you access the setup menu, if you press **NEXT** (left side of switch) repeatedly you will see the following list printed. If you keep pressing **NEXT** (left side) the list repeats itself.

```
*** SETUP MENU ***  
CONFIGURE... [NEXT/OK]  
CUSTOM... [NEXT/OK]  
SET CLOCK... [NEXT/OK]  
RESET SEQ# [NEXT/OK]  
CONFIGURE... [NEXT/OK]
```

This manual assumes the time and date option are installed and operating. If you do not have this option you will not see references to the clock or date listed in most menus.

As you can see from the above printout the setup menu contains the following items:

- CONFIGURE menu
- CUSTOM menu
- SET CLOCK menu
- RESET SEQ#

The following pages explain these items and how to customize the printer to your needs.

CONFIGURE...

The first setup menu item reads

```
CONFIGURE... [NEXT/OK]
```

[NEXT/OK] is a visual clue so you know that pressing the left side of the rocker switch will go to the **NEXT** part of the menu and that pressing the right side of the rocker switch will accept (or say **OK** to) what this line of the setup menu says.

With the printer in the setup menu and with **CONFIGURE...** [NEXT/OK] as the last item printed, press **OK** (right side) to access the configure menu. The following is printed:

```
*** SETUP MENU ***
CONFIGURE...      [NEXT/OK]
*** CONFIGURATION MENU ***
LOAD DEFAULTS    [NEXT/OK]
```

LOAD DEFAULTS gives you the opportunity to reset the printer to all default settings (shown below).

```
*** CONFIGURATION MENU ***
LOAD DEFAULTS    [NEXT/OK]
BAUD=1200       [NEXT/OK]
DATA BITS=8     [NEXT/OK]
STOP BITS=1    [NEXT/OK]
HSHAKE=BUSY-BUFF [NEXT/OK]
COLS=32        [NEXT/OK]
INVERT=NO      [NEXT/OK]
FONT=5x7      [NEXT/OK]
MAG=NONE      [NEXT/OK]
Ready...
```

Choose **OK** to do this or **NEXT** to go to the next parameter. The following is printed:

```
*** SETUP MENU ***
CONFIGURE...      [NEXT/OK]
*** CONFIGURATION MENU ***
LOAD DEFAULTS    [NEXT/OK]
BAUD=1200       [NEXT/OK]
```

Baud rate is the next parameter you can set in the configure menu. The complete list of parameters and their possible values is shown below.

Baud Rate | The sample list above shows the current baud rate is 1200. To accept this, press **OK** (right side) or view the next baud rate value by pressing **NEXT** (left side). Press OK when the baud rate you want is displayed.

Choose from these baud rates;

300, 600, 1200, 2400, 4800, 9600, or 19200

Data Bits | **DATA BITS** is the next parameter. Choose the data bit value the same way baud rate was chosen. Choices are 7 or 8 data bits. Parity will appear next only if you choose 7 data bits.

Parity | If you choose 7 data bits you can select EVEN or ODD parity. If you choose 8 data bits parity defaults to NONE.

Stop Bits | **STOP BITS** is the next parameter. Choose 1 or 2 stop bits.

Handshake | **HANDSHAKE** is the next parameter. Choose from the following settings:

Handshake is used for serial interface only.

BUSY-LINE
BUSY-BUFFER
XON/XOFF-LINE
XON/XOFF-BUFFER
NONE

Cols | **COLUMNS** is the next parameter. Select the number of characters per line (columns) for this parameter. The choices you have are 24, 32, or 40. Below are samples of each:

24 Column Text
32 Column Text
40 Column Text

Invert | **INVERT** is the next parameter. Choose YES if you want inverted text (upside down) or NO if you want non-inverted text (right side up) in your printouts. Below is an example of inverted text.

Inverted Type Sample

Font | **FONT** is the next parameter. Choose from a 5 x 5, 5 x 7, or 5 x 8 dot matrix print pattern. The 5 x 5 dot pattern produces only upper case (capital) letters. The other two fonts can output upper and lower case letters.

5 X 5 TYPE IS ALWAYS CAPITALS

5 x 8 Upper and Lower Case

Mag | The last parameter is **MAGNIFICATION**. This refers to the size of printed type from your printer. Your choices (with examples) are

NONE

NONE

DOUBLE WIDE

DOUBLE WIDE

DOUBLE HIGH

DOUBLE HIGH

DOUBLE WIDE/HIGH

DOUBLE WIDE/HIGH

After you choose one of the magnifications the printer will print **Ready. . .** to show the printer is out of the configuration menu and the setup menu and is ready to print.

CUSTOM. . . | The next setup menu item after **CONFIGURE. . .** is **CUSTOM. . .**. With the printer in the setup menu and with **CUSTOM. . .** as the last item printed, if you press OK (right side) the printer will print the following:

*** SETUP MENU ***
CONFIGURE... [NEXT/OK]
CUSTOM... [NEXT/OK]
***** CUSTOM MENU *****
PRINT CUSTOM SETUP [NEXT/OK]

If you press **OK** the printer will print the current custom setup. A sample is shown below.

```
*** SETUP MENU ***
CONFIGURE...      [NEXT/OK]
CUSTOM...         [NEXT/OK]
***** CUSTOM MENU *****
PRINT CUSTOM SETUP [NEXT/OK]
MM/DD/YY hh:mm ?M DOW [NEXT/OK]
AUTO T&D=NO       [NEXT/OK]
AUTO SEQ=NO       [NEXT/OK]
ZERO=0            [NEXT/OK]
POUND SIGN=#      [NEXT/OK]
_ (Underscore)    [NEXT/OK]
BUSY INVERT=NO    [NEXT/OK]
ONLINE/OFFLINE=YES [NEXT/OK]
EXT CH SET=NO     [NEXT/OK]
PRINT READY=YES   [NEXT/OK]
Ready...
```

This manual assumes the time and date option is installed and operating. If you do not have this option you will not see references to the clock or date listed in most menus.

This printout shows you how each item is currently set. Below is an explanation of each item and the choices you can make for each.

T/D Format

This feature is available only on units with the time/date option installed.

TIME/DATE FORMAT is the next parameter. Choose from the following formats.

```
MM/DD/YY hh:mm ?M
MM/DD/YY hh:mm ?M DOW   MM = month
MM/DD/YY hh:mm          DD = day
MM/DD/YY hh:mm DOW      YY = year
DD-MM-YY hh:mm ?M       hh = hour
DD-MM-YY hh:mm ?M DOW   mm = minutes
DD-MM-YY hh:mm          ?M = AM or PM
DD-MM-YY hh:mm DOW      DOW=Day of
week
DD/MON/YY hh:mm ?M
DD/MON/YY hh:mm ?M DOW
DD/MON/YY hh:mm
DD/MON/YY hh:mm DOW
NONE
```

Auto T&D	<p>AUTO TIME AND DATE is the next parameter. Your choices are</p> <p style="padding-left: 40px;">YES - autoprnt after CR (carriage return) NO - do not autoprnt after CR</p> <p>Autoprnt of the time and date will not occur unless three seconds has elapsed since the printer has stopped printing.</p>
Auto Seq#	<p>AUTO SEQUENCE NUMBER is the next parameter. Choose</p> <p style="padding-left: 40px;">NO - don't autoprnt sequence number after CR YES - do autoprnt sequence number after CR</p> <p>Autoprnt of the sequence number will not occur unless three seconds has elapsed since the printer has stopped printing.</p>
Zero	<p>ZERO is the next parameter. Choose how you want the zero character to look in your printouts. Choose between 0 and 0.</p>
Pound Sign	<p>POUND SIGN is the next parameter. Choose to show pound as # or as the British sterling pound symbol £.</p>
_Underscore	<p>_UNDERSCORE is the next parameter. Choose which symbol the same ASCII code will print, an _underscore or a ← left arrow.</p>
Busy Invert	<p>BUSY INVERT is next. Choices:</p> <p style="padding-left: 40px;">NO - voltage will be in a high state until the unit is busy then voltage level goes low.</p> <p style="padding-left: 40px;">YES -voltage will be in a low state until the unit is busy then voltage level goes high.</p>

Online/Offline

ONLINE/OFFLINE is next.

Choices:

YES - enables the rocker switch to turn the printer offline.

NO - disables the ONLINE/OFFLINE ability.

Ext Ch Set

The choice to use the extended character set is available only when 8 data bits are chosen.

EXT CH SET is next. This stands for Extended Character Set.

Choices:

YES - Allows you to use hexadecimal numbers above 80 (true only for 8 data bits.)

NO - Disables the Extended Character Set ability.

Print Ready

PRINT READY is next.

Choices:

YES - Prints **Ready. . .** upon power up.

NO - Disables printing **Ready. . .**

WARNING - If you choose **NO**, hold the left side of the rocker switch down for 4-6 seconds to access the setup menu. Begin timing when you connect power to the unit and the red light comes on. The paper feed motor does not run upon power up when **Ready. . .** is disabled.

SETCLOCK. . .

This feature is available only on units with the time/date option installed.

The next item in the Setup Menu is **SET CLOCK. . .**

With the printer in the setup menu and with **SET CLOCK. . .** as the last item printed, if you press **OK** (right side) the printer will print the following:

```
SET CLOCK... [NEXT/OK]
*** SET DATE ***
Set Year: 95.....[NEXT/OK]
```

The printout shows the year currently in memory. The **9** is reversed (white on black) to show the position of the cursor. This is the number which will be incremented if **NEXT** (left side) is pressed. If the number is correct press **OK** (right side) and the following is printed:

```
SET CLOCK... [NEXT/OK]
*** SET DATE ***
Set Year: 95.....[NEXT/OK]
Set Year: 95.....[NEXT/OK]
```

The cursor now appears over the 2nd position. Press **NEXT** (left side) to increment this number if needed and **OK** if it is right. Continue this sequence of accepting or changing the year, month, day, and DOW (Day Of Week).

```
SET CLOCK... [NEXT/OK]
*** SET DATE ***
Set Year: 95.....[NEXT/OK]
Set Year: 95.....[NEXT/OK]
Set Mon : 09.....[NEXT/OK]
Set Mon : 09.....[NEXT/OK]
Set Day : 13.....[NEXT/OK]
Set Day : 13.....[NEXT/OK]
Set DOW : 4.....[NEXT/OK]
```

When you have completed the **SET DATE** menu the following is printed automatically:

```
*** SET TIME ***  
Set Hour: 16.....[NEXT/OK]
```

Choose **NEXT** (left side) to increment the number or **OK** (right side) to accept the 1. Repeat this same procedure for hours and minutes as shown below.

```
*** SET TIME ***  
Set Hour: 16.....[NEXT/OK]  
Set Hour: 18.....[NEXT/OK]  
Set Min : 06.....[NEXT/OK]  
Set Min : 38.....[NEXT/OK]  
Start Clock .....[OK]  
Ready...
```

When everything is as you want it and you press **OK**, **START CLOCK** is printed. Press **OK** (right side) to start the clock. The printer then prints **Ready. . .** showing you that it is out of the setup menu and ready to print.

RESET SEQ#

RESET SEQ# is the last setup menu item. This menu item lets you reset the sequence number. This number is the number of print transactions since the last reset.

With the printer in the setup menu and with **RESET SEQ#** as the last item printed, if you press **OK** (right side) the sequence number will be reset to zero and the printer will print **Ready. . .** showing it is no longer in the setup menu and that the printer is ready to print.

To skip resetting the sequence number to zero, press **NEXT** (left side). **CONFIGURE. . .** is printed. Unplug and replug in the printer to return to printing mode. **Ready. . .** is printed.

Communication

RS-232 Serial Version

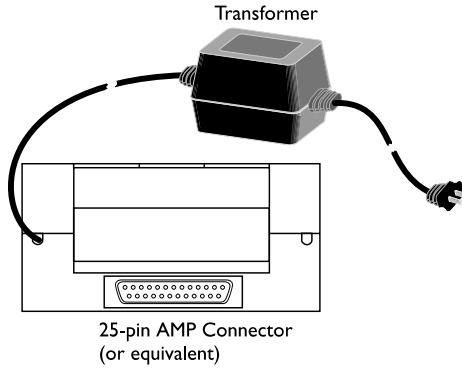

Pin No.	Signal	DTE Direction	Description
1	Chassis ground	-	Cable shield
2	(TD) Transmitted data	From printer	Printer data output line
3	(RD) Received data	To printer	Printer data input line
7	(SG) Signal ground	-	Signal ground
10	+12VDC	To printer	Only w/9-12VDC option
11	(CTS) Clear to send	From printer	Signal (equivalent to BUSY) indicating that printer is ready for operation and can receive data.
21	Power return	To printer	Only w/9-12VDC option

The rest are not used.

Serial Interface Voltage Levels

Received data: Mark = OFF = Logic "1" = -25V to -3V
 Space = ON = Logic "0" = +25V to +3V

Clear to send: Busy = OFF = Logic "1" = -9V
 Not Busy = ON = Logic "0" = +9V

Transmitted data: Mark = OFF = Logic "1" = -9V
 Space = ON = Logic "0" = +9V

20 mA Current Loop Version

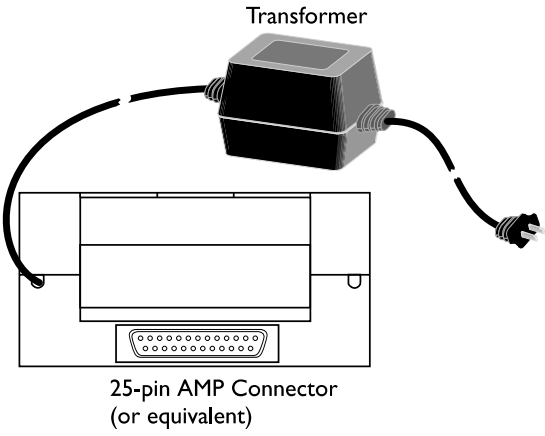

Pin No.	Signal	Direction	Description
1*	Chassis ground	-	Cable shield
23	(RD) Received data(-)	From printer	printer data return line
25	(RD) Received data(+)	To printer	printer data input line

*Optional

Serial Connector Pin Arrangement

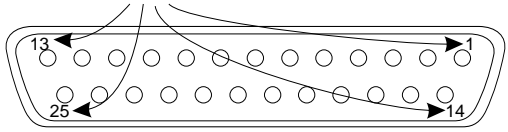

- Connectors
 On the printer: 25-hole receptacle, equivalent to DB-25S (Canon)
 On the cable: 25-pin plug, equivalent to DB-25P (Canon) Shell equivalent to DB-C2-J9 (Canon)

Control Codes

According to the American Standard Code of Information Interchange (ASCII), there are 32 control codes in addition to the codes for the printable characters. (Control codes are sent as data, but the receiving device interprets them as abbreviated "instructions", communication - status messages, etc.)

The printer recognizes these control codes:

Function	Abbreviation	Code	
		Hex	Decimal
-	NUL	00	0
-	SOH	01	1
Reserved	STX	02	2
Reserved	ETX	03	3
-	EOT	04	4
-	ENQ	05	5
Reserved	ACK	06	6
-	BEL	07	7
Back Space	BS	08	8
-	HT	09	9
Line Feed	LF	0A	10
-	VT	0B	11
-	FF	0C	12
Carriage Return	CR	0D	13
Double Height	SO	0E	14
Double Width	SI	0F	15
Reset Seq. # to 0000	DLE	10	16
Inhibit Line Space	DC1	11	17
User Character	DC3	13	19
Set Time & Date	DC4	14	20
Reserved	NAK	15	21
Get time and date	SYN	16	22
-	ETB	17	23
Stop Reverse Field	CAN	18	24
Reverse Field	EM	19	25
Set Printer Config.	SUB	1A	26
Escape	ESC	1B	27
-	FS	1C	28
24 Column Mode	GS	1D	29
32 Column Mode	RS	1E	30
40 Column Mode	US	1F	31

The printer will ignore all other control codes.

**Back Space
Code 8**

Upon receipt of this code, the printer erases from its buffer the previously received character. This is useful in correcting typing errors for programs that send data both to a video screen and the hardcopy printer. Remember that if you type more characters than the printer can print on a line, the printer will automatically start printing.

**Line Feed
Code 10**

The printer handles this control code in exactly the same manner as carriage return (control code 13) except when a line feed immediately follows a carriage return. The line feed code is ignored if it is immediately preceded by a carriage return. The default setting is 7.4 lines per inch.

**Carriage Return
Code 13**

Whenever a carriage return code is received, the printer will print out the current contents of its buffer, then clear the buffer to get ready for additional data.

**Double Height
Code 14**

This control code tells the printer to switch to the double height character line. The control code can be sent at any time on a line, it need not be the first code received by the printer after a carriage return.

You cannot mix normal and double height characters on the same line. Once you select the double height, the printer will remain in that mode until it receives a carriage return or line feed. A line print caused by a buffer full condition will not clear the double height command. This means that the "wrap around" print line will also be double height if the double height command was sent before the line buffer was filled.

**Double Width
Code 15**

This control code tells the printer to switch to double width character printing. The control code should be sent as the first character on a line. If it is received after half the maximum characters per line were sent then the printer will ignore all characters on the last half of the line.

You cannot mix normal and double width characters on the same line. Once you select the double width, the printer will remain in that mode until it receives a carriage return or line feed. A line print caused by a buffer full condition will not clear the double width command. This means that the "wrap around" print line will also be double width if the double width command was sent before the line buffer was filled.

**Enlarged Printing
Codes 14 and 15**

Enlarged printing may be selected by sending both the double height command (code 14) and the double width command (control 15). The control codes may be sent in either order, but because of the double width restrictions, the codes should be sent at the beginning of a line.

Example of Control Codes 14 and 15:



**Reset Sequence
Number
Code 16**

When the printer receives this control code it will immediately reset the sequence number to 00000.

**Inhibit Line Spacing
Code 17**

A standard character line is made up of ten dot lines. Eight of these dot lines are used for the printable character and two are used for space between lines. When using character graphics it is desirable to eliminate the two blank lines so the graphic characters connect together. Sending a CHR\$(17) which is control code 17 anywhere on a line of data will stop the printer from putting space between that line and the next. If a CHR\$(17) is not on a print line, the normal space between lines will be printed.

Example:

```
10 BS=CHR$(17)
20 LPRINT " "
30 LPRINT " "
40 LPRINT " "
50 LPRINT " "
60 LPRINT " "
```

Run:



**User Programmable
Character
Code 19**

By using CHR\$(1) you enter the Custom Character mode. This allows you to design and print your own 6 x 8 character by inputting data. A DATA statement is made of numbers that represent a row of dots which when READ all together, will make up your character. To design your character, follow the example below. You should notice that each number in the DATA statement corresponds to one row in your character. To design a character, follow these steps:

1. Use quad ruled paper to design your character.
2. Number 8 consecutive rows like this:

1
2
4
8
16
32
64
128

3. Now design your character in dot form (see the example below).
4. Add together all the numbers from the column on the left, counting only where you have placed a dot in a row. In our example, the first column has three dots located in rows 4, 8, and 16. Added together they equal 28.
5. Put your final total for each column into a data statement in column order.

1			●	●		
2		●			●	●
4	●				●	
8	●					
16	●				●	
32		●			●	●
64			●	●		
128						
	28	34	65	65	54	34

The DATA statement in your program will read:

```
DATA 28, 34, 65, 65, 54, 34
```

The next step is to tell the printer your newly designed character. To do this you must send a CHR\$(19) followed by the six numbers you computed above. Here is an example of how this can be done.

```
10 DATA 28,34,65,65,54,34
20 LPRINT CHR$(19);
30 FOR I=1 TO 6
40 READ A
50 LPRINT CHR$(A);
60 NEXT I
70 LPRINT "This is the programmed"
80 LPRINT"character "CHR $(126)". "
90 END
```

This is the programmed character C.

After typing RUN, your custom character will be stored in the printer's memory. It will retain this information until the printer is switched off or until you write over the data by defining a different character.

To print your newly designed character, simply send CHR\$(126) which corresponds to hexadecimal value 7E.

**Set Time and Date
Control Code 20**

This control code is used when setting the printer's time and date clock.

**Read Time and
Date
Control Code 22**

This control code is used to read the printer's time and date clock.

**Cancel Reverse
Field
Control Code 24**

Sending this control code will turn OFF the reverse field mode that is selected using control code 25.

**Reverse Field
Control Code 25**

Send this control code to turn ON the reverse field printing mode. This will print white letters on a dark background. Do not print more than three reverse field print lines. Also, do not print more than a few empty spaces in a reverse field. The printer may become overloaded and stop printing.

**Set Printer Config.
Code 26**

This control code is used when setting the printer's various configuration parameters.

**Selectable Column
Width
Codes 29, 30, 31**

The printer powers up in the column mode last selected by configuration. You can change the column width by sending the appropriate control code from the list below:

Control code 29 - 24 columns

Control code 30 - 32 columns

Control code 31 - 40 columns

You can send the control code at any point on a line before the buffer becomes filled. You cannot change column widths on the same line.

Printable Characters

The WP-234 printer can produce all ASCII characters from hex 20 through hex 7D (decimal 32 through 125). Here's what they look like:

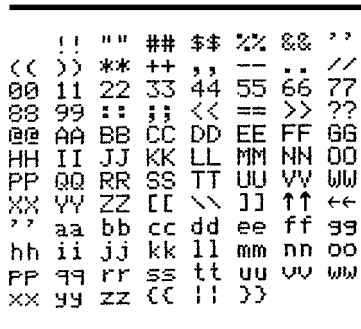

Note the last two codes of the usual ASCII character set are not supported. Instead, if CHR\$(126), which corresponds to hexadecimal 7E, is received by the printer, it will print the character defined in its RAM (Random Access Memory). The section on USER Programmable Character describes how this RAM can be loaded with any 6 x 8 pattern.

The WP-234 also has a graphic character set that resides between hexadecimal values 80 and FF (decimal 128 and 255). The symbols used are compatible with Radio Shack's Model 100 portable computer.

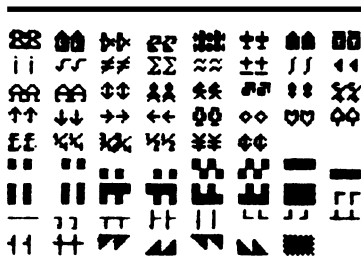

For solid graphics applications please contact your Weigh-Tronix supplier.

**Printer Escape
Command Code
Definitions**

Command	Print formatted data
<ESC> 0	HH:MM 24 hour format
<ESC> 1	HH:MM_?M 12 hour format with AM or PM
<ESC> 2	MM/DD/YY month/day/year
<ESC> 3	DD-MM-YY day-month-year/numeric month
<ESC> 4	DD-MON-YY day-month-year with 3 letter abbreviation of the month
<ESC> 5	DOW day of week abbreviation
<ESC> 6	currently configured format
<ESC> 9	XXXX current sequence number

Weigh-Tronix

1000 Armstrong Dr.
Fairmont, MN 56031 USA
Telephone: 507-238-4461
Facsimile: 507-238-4195
e-mail: industrial@weigh-tronix.com
www.weigh-tronix.com

Weigh-Tronix Canada, ULC

217 Brunswick Blvd.
Pointe Claire, QC H9R 4R7 Canada
Telephone: 514-695-0380
Facsimile: 514-695-6820

WEIGH-TRONIX

Weighing Products & Systems